

CUTTING PLOTTER

CG-60SR
CUTTING PLOTTER

QUICK REFERENCE GUIDE

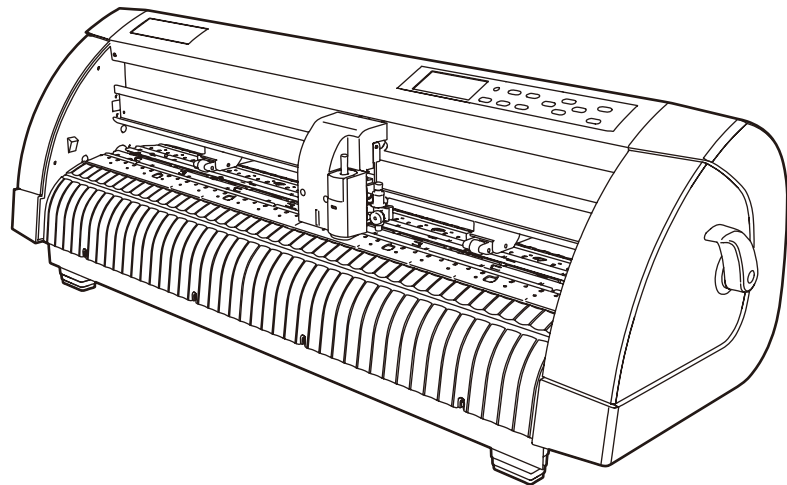

MIMAKI ENGINEERING CO., LTD.

TKB Gotenyama Building, 5-9-41, Kitashinagawa, Shinagawa-ku,
Tokyo 141-0001, Japan

Phone: +81-3-5420-8671 Fax: +81-3-5420-8687

URL: <http://www.mimaki.co.jp/>

D201651-14

Quick Reference Guide

TABLE OF CONTENTS

Foreword	3
CAUTION	4
DISCLAIMER OF WARRANTY	4
Requests	4
FCC Statement (USA)	4
Interference to televisions and radios	4
About media	4
Safety Precautions	5
Symbols	5
Safety Labels	7
Checking the accessories	8
Configuration and function	9
The Front	9
The Rear	9
Operation Panel	10
Connecting the cables	11
USB Cable Connection	11
Connecting the power cable	11
Operation flow	12
Installing a tool	13
Using a cutter	13
How to Install a Ballpoint Pen	16
Mount the Manual Cutter.	17
Turning the power on	19
Setting the tool conditions	20
Kinds of the Tool Conditions	20
Set the Tool Conditions.	21
Loading a sheet of media	23
Loading a leaf sheet (cut sheet)	25
How to Place the Roll Sheet	27
Test cutting (plotting)	29
Cutting (plotting)	30
Setting the origin	30
Start cutting (plotting)	31
Cut off the Sheet (Manual Cutting)	32
Turning the power off	33

Cut Out Data with Registration Mark	34
Making sticker with a register mark (When using FineCut)	34
Enter the registration mark detection mode	35
Precautions in inputting data with registration marks	36
Set for Detecting the Registration Marks	40
Method of detecting registration marks	45
Confirm the following when failed in cutting correctly.	52

Foreword

Congratulations on your purchase of Mimaki cutting plotter CG-60SR.
This guide explains basic operation of CG-60SR.
For more details, please refer to the “CG-60SR Operation Manual” supplied with the attached plugin software FineCut CD-ROM.

DISCLAIMER OF WARRANTY

DISCLAIMER OF WARRANTY : THIS LIMITED WARRANTY OF MIMAKI SHALL BE THE SOLE AND EXCLUSIVE WARRANTY AND IS IN LIEU OF ALL OTHER WARRANTIES, EXPRESS OR IMPLIED, INCLUDING, BUT NOT LIMITED TO, ANY IMPLIED WARRANTY OF MERCHANTABILITY OR FITNESS, AND MIMAKI NEITHER ASSUMES NOR AUTHORIZES DEALER TO ASSUME FOR IT ANY OTHER OBLIGATION OR LIABILITY OR MAKE ANY OTHER WARRANTY OR MAKE ANY OTHER WARRANTY IN CONNECTION WITH ANY PRODUCT WITHOUT MIMAKI' S PRIOR WRITTEN CONSENT. IN NO EVENT SHALL MIMAKI BE LIABLE FOR SPECIAL, INCIDENTAL OR CONSEQUENTIAL DAMAGES OR FOR LOSS OF PROFITS OF DEALER OR CUSTOMERS OF ANY PRODUCT.

Requests

- This Operation manual has been carefully prepared for your easy understanding. However, please do not hesitate to contact a distributor in your district or our office if you have any inquiry.
- Description contained in this Operation manual are subject to change without notice for improvement.

FCC Statement (USA)

This equipment has been tested and found to comply with the limits for a Class A digital device, pursuant to Part 15 of the FCC Rules. These limits are designed to provide reasonable protection against harmful interference when the equipment is operated in a commercial environment. This equipment generates, uses and can radiate radio frequency energy and, if not installed and used in accordance with the Operation manual, may cause harmful interference to radio communications. Operation of this equipment in a residential area is likely to cause harmful interference in which case the user will be required to correct the interference at his own expense.



- In the case where MIMAKI-recommended cable is not used for connection of this device, limits provided by FCC rules can be exceeded. To prevent this, use of MIMAKI-recommended cable is essential for the connection of this plotter.

Interference to televisions and radios

The product described in this manual generates high frequency when operating. The product can interfere with radios and televisions if set up or commissioned under improper conditions. The product is not guaranteed against any damage to specific-purpose radio and televisions. The product's interference with your radio or television will be checked by turning on/off the power switch of the product.

In the event that the product is the cause of interference, try to eliminate it by taking one of the following corrective measures or taking some of them in combination.

- Change the orientation of the antenna of the television set or radio to find a position without reception difficulty.
- Separate the television set or radio from this product.
- Plug the power cord of this product into an outlet which is isolated from power circuits connected to the television set or radio.

About media











Please follow the local regulations to dispose of roll sheets or other media.





Safety Precautions











Symbols

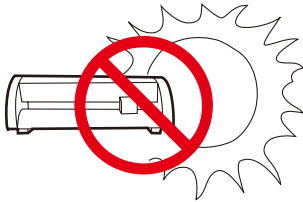

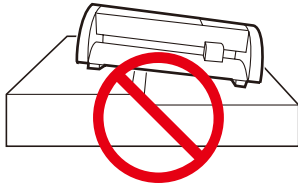

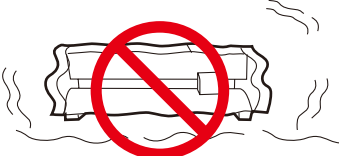

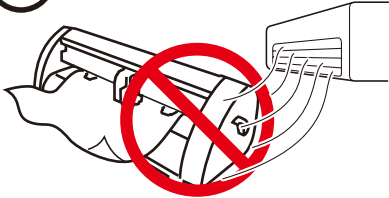
Symbols are used in this Operation Manual for safe operation and for prevention of damage to the machine. The indicated sign is different depending on the content of caution. Symbols and their meanings are given below. Please follow these instructions as you read this manual.

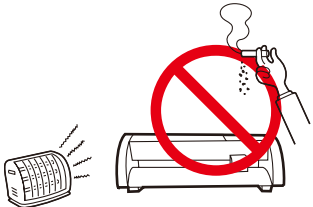
Examples of symbols

	Meaning
	Failure to observe the instructions given with this symbol can result in death or serious injuries to personnel. Be sure to read and observe the instructions for proper operation.
	Failure to observe the instructions given with this symbol can result in injuries to personnel or damage to property.
	This symbol indicates that the information is helpful in proper operation of the plotter.
	This symbol indicates that it is important to know of the information on proper operation of the plotter. Use this information for your operation.
	Indicates the reference page for related contents.
	The symbol "  " indicates that the instructions must be observed as strictly as the CAUTION instructions (including DANGER and WARNING instructions). A sign representing a precaution (the sign shown at left warns of hazardous voltage) is shown in the triangle.
	The symbol "  " indicates that the action shown is prohibited. A sign representing a prohibited action (the sign shown at left prohibits disassembly) is shown in or around the circle.
	The symbol "  " indicates that the action shown must be taken without fail or the instructions must be observed without fail. A sign representing a particular instruction (the sign shown at left instructs to unplug the cable from the wall outlet) is shown in the circle.

 WARNING	
Do not disassemble or remodel the plotter.	Handling of the power cable
 <ul style="list-style-type: none"> Never disassemble or remodel the plotter. Disassembly or remodeling can result in an electric shock or breakdown of the machine. Do not use the plotter in a damp place. 	 <ul style="list-style-type: none"> Use the supplied power cable. Take care not to damage, break or work upon the power cable. If a heavy material is placed on the power cable, or if it is heated or pulled, the power cable can break, thus resulting in fire or electric shocks.
Avoid locating the plotter in a damp environment.	
 <ul style="list-style-type: none"> Do not splash water onto the machine. Use in such an environment can give rise to fire, electric shocks or breakdown of the plotter. 	
In case abnormal event occurs.	
 <ul style="list-style-type: none"> Use of the plotter under an abnormal condition where the device produces smoke or strange smell can result in fire or electric shocks. If such an abnormality is found, be sure to turn off the power switch immediately and unplug the cable from the wall outlet. Check first that the plotter no longer produces smoke, and contact your distributor for repair. Never repair your plotter by yourself since it is very dangerous for you to do so. 	

 CAUTION		
A place exposed to direct sunlight	On an inclined surface	A place where temperature or humidity varies significantly
 	 	 <ul style="list-style-type: none"> Use the plotter under the following environmental conditions: Operating environment: 20 to 35° C 35 to 65% (Rh)
A place that vibrates	A place exposed to direct air flow from an air conditioner or the like.	Around a place where flame is used
 	 	 

 CAUTION	
Be careful with the movable parts	Sheets
 <ul style="list-style-type: none"> Do not touch the rolling grit roller; otherwise, you may hurt your fingers or tear off your finger nails. 	 <ul style="list-style-type: none"> Straighten the sheet of media, if significantly curled, before using it for printing. Heavily curled sheet affects the cutting (plotting) result.
 <ul style="list-style-type: none"> Keep your head and hands away from any moving parts during cutting (plotting) operation; otherwise, you may get your hair caught in the machine or get injuries. 	Caution with cutters
 <ul style="list-style-type: none"> Wear proper clothes. (Do not wear loose-fit clothes or accessories). Bind a long hair. 	 <ul style="list-style-type: none"> Do not touch the cutter blade, which is very sharp. Do not shake or swing the cutter holder; otherwise, the blade may come off.

Safety Labels

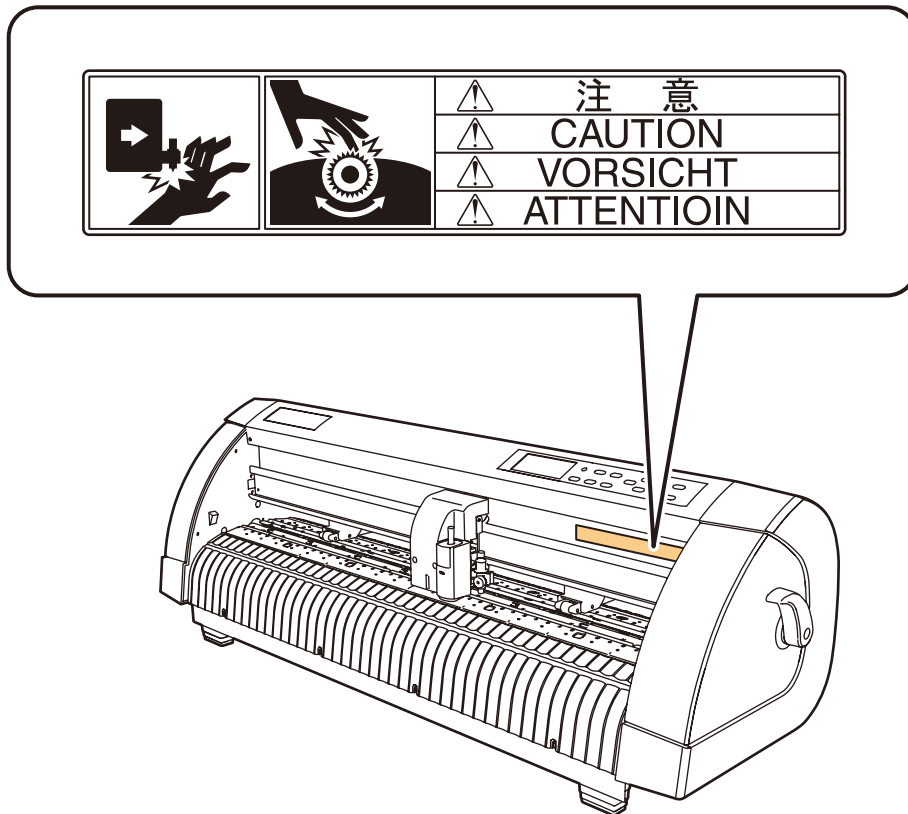

Checking the accessories

The articles illustrated below are supplied with your plotter as accessories.
Check them for correct quantities and appearance. If you find any problem, please contact your distributor.

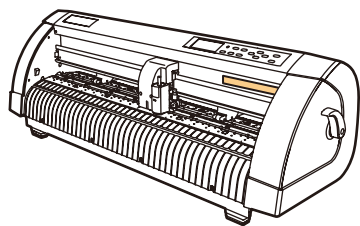

Main unit



Cutter blade
(for Vinyl)



Cutter holder
(Provided with blade)

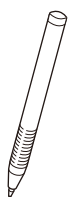

Ball-point pen
(Black, Marketed item)

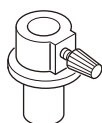

Ball-point pen adapter
(Mounted on the main
unit at the factory before
shipment)



Cap

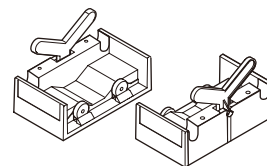

Roll-placing table

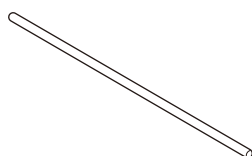

Sheet Support



Cutter blade for
manual cutting
(Five bladed x 3pieces)

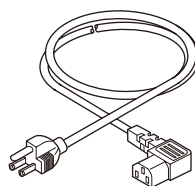

Power cable

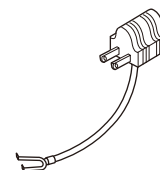

Grounded plug adapter
(This is not packaged
depend on the
desitainion)

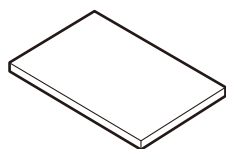

CD-ROM
(USB Driver)
(Plug-in software FineCut)

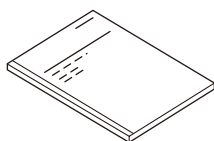

Quick Reference Guide



Arrow Sticker

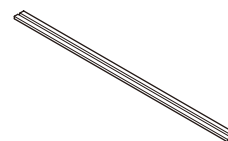

Pen Line

Configuration and function

The Front

Carriage

The carriage carries the pen and moves it up and down.

Operation panel

The plotter is operated and functions are set on the operation panel. (☞ P.10)

Power switch

The switch turn on/off the power. (☞ P.19, P.33)

Clamp lever

Pushing a lever down lowers a pinch roller and retain the sheet.

Platen

The sheet of media moves along the platen.

Grit roller

The grit rollers operate in combination with the pinch rollers to feed the sheet.

Pinch roller

The pinch rollers feed out the sheet while pressing it against the grit rollers.

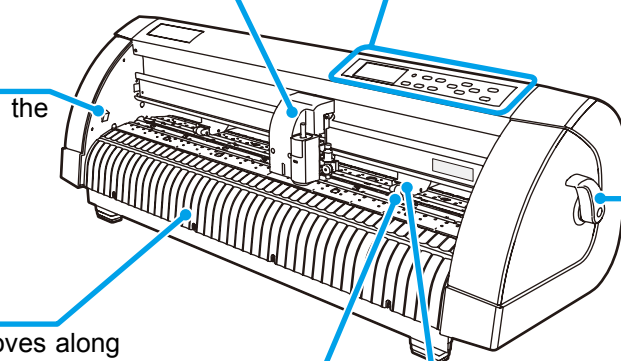

The Rear

Tray

Small tools, such as a retractable knife and other cutters, may be placed on the tray.

USB interface connector

The USB interface connector. Connected to the USB connector of the host computer through a USB interface cable. (☞ P.11)

Clamp pressure lever

This lever adjusts the force by which the clamp is held.

AC inlet

The power cable is connected to the AC inlet. (☞ P.11)

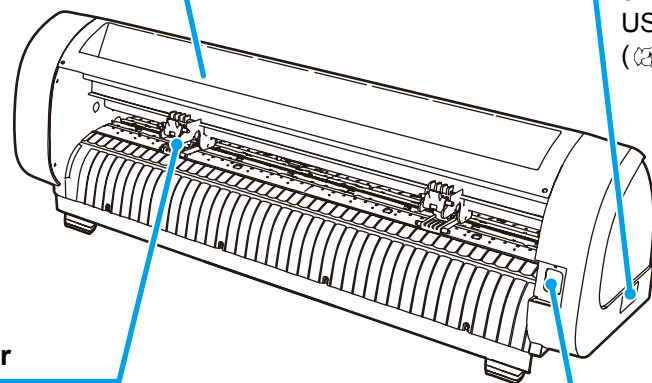

Operation Panel

Display panel

The display panel indicates tool conditions such as speed, pressure and offset, tool coordinates, functions and error messages.

SHEET SET key

Use this key for detection of the sheet or clearing of the detection result. (P.23)

POWER lamp

This lamp lights up when the power to the plotter is turned on.

FUNCTION key

Use this key to enter function setting mode.

JOG Key

Each of these arrow keys shifts the carriage or sheet in the direction of the arrow or changes settings. (P.10)

END key

This key cancels the last input value or returns the setting menu to the immediate higher level in the hierarchy. Use the key to detect only the sheet width.

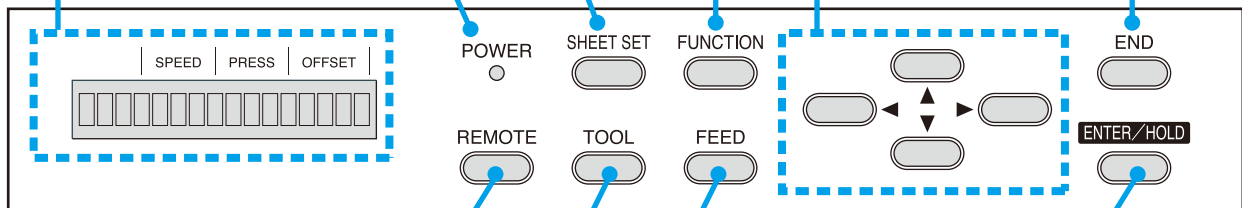

REMOTE key

This key switches the operation mode between REMOTE mode and LOCAL mode. If this key is pressed when the plotter is in operation, the plotter will come to a halt. Press the key again to restart the plotter,

TOOL key

Use this key to select a tool and establish tool conditions.

FEED key

Press this key to execute sheet feeding.

ENTER/HOLD key

This key registers the last input value as the setting value or returns the setting menu to the immediate lower level in the hierarchy. Use the key to correct the drifting of the sheet during cutting (plotting) operation.

Jog keys

The arrow keys are used as described in the table below.

	Before the detection of a sheet	After the detection of a sheet	When selecting a function	When selecting a setting value
	Detects the sheet width.	Shifts the carriage to the left.	—	—
	Detects the width and length of the sheet.	Shifts the carriage to the right.	—	—
	Detects the sheet width.	Move the sheet toward the rear of the plotter.	1Restores the previous function.	Selects the previous value.
	Detects the width and length of the sheet.	Move the sheet toward the front of the plotter.	Selects the next function.	Selects the next value.

In this manual, the sheets of media other than roll sheets are referred to as leaf sheets or cut sheets.

Connecting the cables

USB Cable Connection

When you want to connect the USB cable, you must observe the following notabilia.

Important!

- Do not plug in or unplug any cable during data transferring.
- Follow the instructions on the LCD if the wizard is displayed when connecting the USB cable.

Connecting USB driver

As for USB driver connection, refer to “USB Driver Installation Guide” in the supplied FineCut.

- (1) Set the CD supplied with FineCut into the disk drive.
- (2) Click [CD-ROM Contents] on the menu.
- (3) Open [usb11_installguid(en).pdf] for the plotter used in [Mimaki USB1.1 Driver] folder.

Connector ports

This plotter uses the USB connector for connection to the host computer.

Important!

- Connect or disconnect the connectors carefully. Applying undue force to a connector may damage the connector.

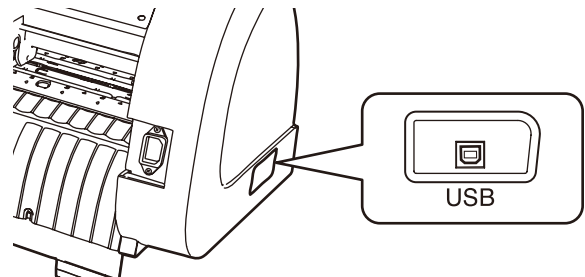

Connecting the power cable

After connecting the interface cable, you must connect the power cable. Connect the power cable with the plug outlet of the following power specifications.

- Voltage : AC100 - 240V \pm 10%
- Frequency : 50/60Hz
- Capacity : 145 VA or less

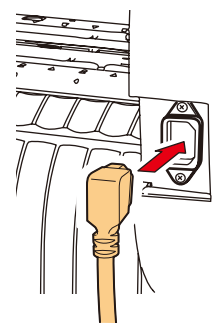

Be sure to connect the ground wire.

- Using without the ground wire causes the damage of this device and electric shock that may be very dangerous.

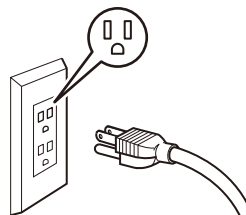

Regarding the use of two polar plug outlet, you must connect the auxiliary ground adapter to the plug of power cable.

- Earth the green wire (ground wire) of the ground adapter. If you cannot, consult with an electrician.

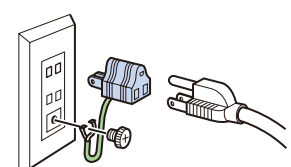

Operation flow

1

Installing a tool

See "Installing a tool" (👉 P.13)

2

Mount the Manual Cutter.

See "Mount the Manual Cutter."
(👉 P.17)

3

Turning the power on

See "Turning the power on"
(👉 P.19)

4

Setting the tool conditions

See "Setting the tool conditions"
(👉 P.20)

5

Loading a sheet of media

See "Loading a sheet of media"
(👉 P.23)

6

Test cutting (plotting)

See "Test cutting (plotting)"
(👉 P.29)

7

Cutting (plotting)

See "Cutting (plotting)" (👉 P.30)

8

Turning the power off

See "Turning the power off"
(👉 P.33)

Installing a tool

For this device, you can use the following tools.

- Cutter** : Select this to cut the image printed on a sheet and to create the cut letters with the cutting sheet.
- Pen (rollerball)** : Select this to “trial-write” for confirming how to actually cut.
- Pouncing Pin (option)** : Select this to sketch the cutting line.

Using a cutter



- Don't touch the cutter blade with your fingers.
->Sharp cutter edge may cause to injure you.
- After setting the cutter, don't shake the tool.
->The cutter edge may pop out and may cause to injure you.

How to install a cutter blade

1 Take out the cutter holder.

2 Loosen the lock nut, and pull the adjusting knob out of the holder.

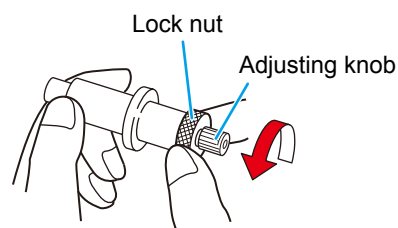

3 Insert the cutter blade into the adjusting knob using tweezers.

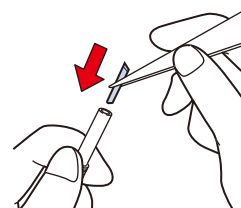

4 Tighten the lock nut.

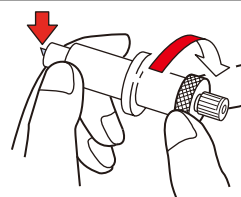

Adjusting the protrusion of the cutter blade

Adjust the cutter blade according to the types of the cutters and the sheet for use.

After adjusting the protrusion of the cutter blade, set the cutting conditions and conduct test cutting to check the cutting quality.

Important!

- Take care not to protrude the blade too much. If the cutter is used with its blade excessively protruded, the cutter can cut out the base paper, thus damaging the main unit.

1

Take off the cutter holder and loosen the Lock nut.

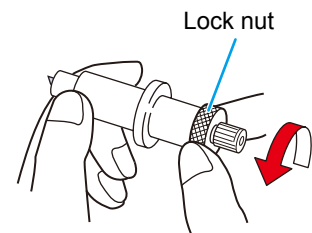

2

Turn the adjusting knob to adjust the protruding amount of the cutter blade.

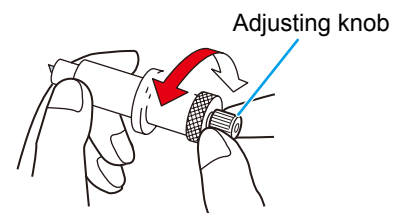

3

Tighten the lock nut so that the adjusting knob will not turn.



How to install the cutter

Important!

- Install the cutter to the tool holder of the carriage. Be sure to insert the cutter all the way in the tool holder.

1

Inset the cutter into the tool holder.

- Push the brim of the cutter against the holder.

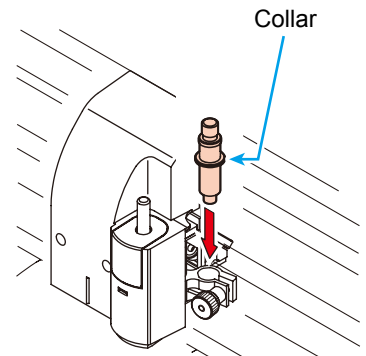

2

Fix the cutter holder.

- Turn the finger grip clockwise, and surely fix it.

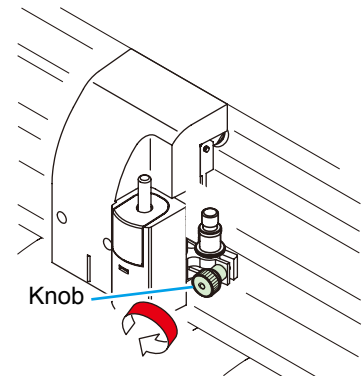

Important!

- Fix the cutter firmly. If not, accurate and high-quality cutting (plotting) will not be achieved.

How to Install a Ballpoint Pen

Important!

- When use a boll-point pen on the market, refer to the oeration manual and select a installable boll-point pen.

1

Put the cap on the pen adapter.

- Use the cap to adjust the pen height.

2

Insert the pen into the pen adapter.

- Insert the pen until the pen head reaches the cap.

3

Fix the pen tip.

- Tighten the fixing screw clockwise.
- Be careful not to over-tighten the fixing screw for the pen adapter. If tightened too much, the ball-point pen may crack.

4

Remove the cap.

5

Insert the pen adapter with the pen into the tool holder.

- Make sure that the collar of the pen adapter is rested on the holder.
- Set the adapter in such a way that the fixing screw will not obstruct operation.

6

Turn the knob of the tool holder clockwise to fix the tool.

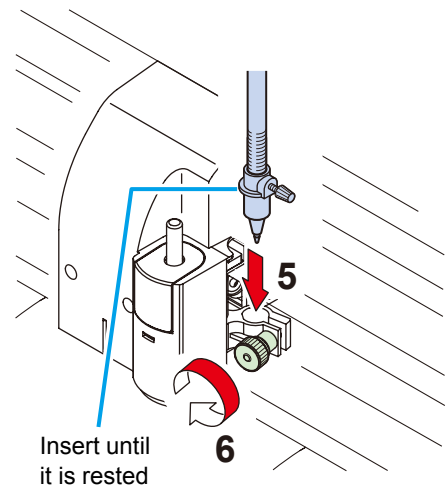
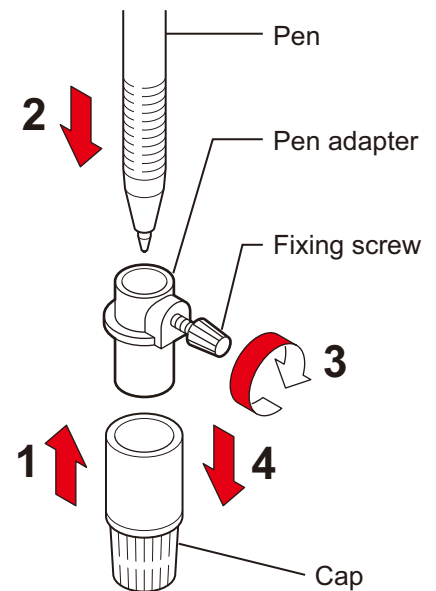

Mount the Manual Cutter.

You can use the manual cutter when you want to cut the sheet after you cut (plot).
(Cutter blade is not installed at factory for safety reasons. Install the blade according to the following procedure.)



- Don't touch the cutter blade with your fingers.
->Sharp cutter edge may cause to injure you.
- After you set the cutter, don't shake the manual cutter.
->The cutter edge may pop out and may cause to injure you.

1

Take off the cover of the manual cutter.

- (1) Insert the flat head into the hole under the manual cutter cover,
- (2) and pull it up pressing the pawl of the manual cutter.

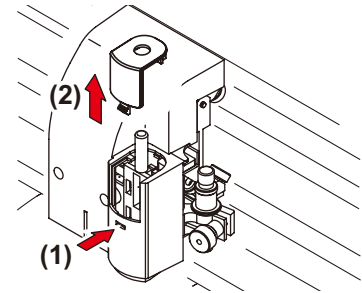

2

Take off the manual cutter.

- Pull the finger grip and hold it up.

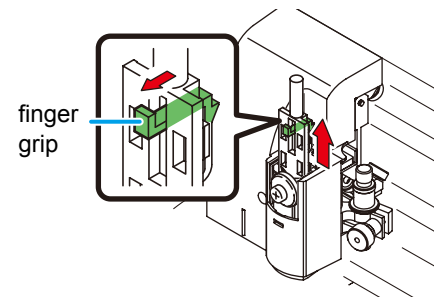

3

Take out the “Cutter blade for manual cutter” from accessories, and fold the blade with a nipper or the like.

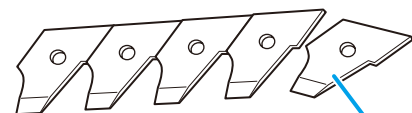

Fold a blade with a nipper or the like.

4

Set the cutter blade.

- (1) Remove a screw of cutter roller.
- (2) Insert the cutter so as to fit in the slot,
- (3) Place the convexity part of cutter roller toward cutter blade.
- (4) Tighten the screw.

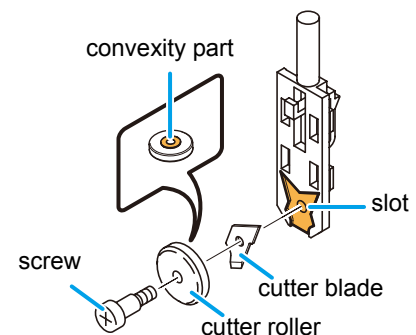

5

Mount the manual cutter on the device.

- (1) Hold the cutter so that the screw may come near to you,
- (2) Fix the slot of the manual cutter with that of the device,
- (3) Mount the cutter for sure so that you can hear a click sound.

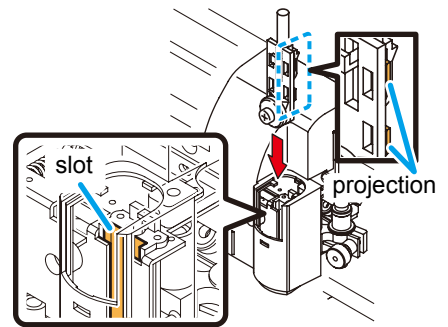

6

Paste the arrow sticker on manual cutter cover.

- Paste the arrow sticker (accessories), which indicate the cut direction, according to the installed cutter blade direction.

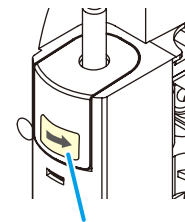

Paste the arrow sticker

Turning the power on

Important!

- Before turning the power on, check that the pinch rollers have been raised.
- Be sure to turn on the host computer before turning on the plotter. If this order is not correctly followed, the plotter can malfunction.
- Once the power is turned off, wait at least five seconds before turning the power on again.

1

Press the “ | ” side of the power switch.

- When the plotter is turned on, it will enter the first operation mode, which are followed by the subsequent modes. Refer to page 1-15 for the operation modes.

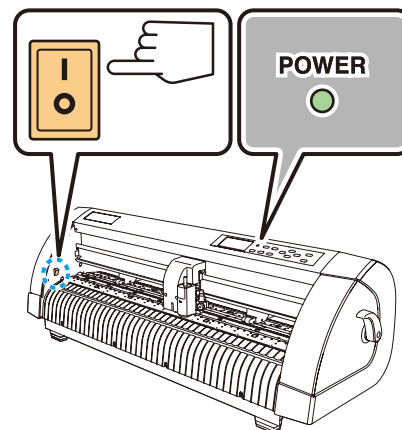

2

The POWER indicator lamp lights up green.

- The sheet suction fan rotates.

3

Check the receiving buffer.

- Then, the tool conditions for the currently selected tool appears on the LCD.

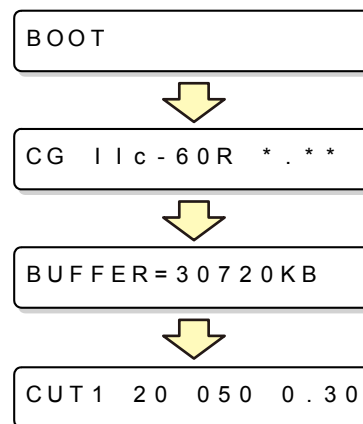

Setting the tool conditions

You must set the tool conditions adjusting to your use.

Kinds of the Tool Conditions

The kinds of the tool conditions include cutting and plotting conditions.
See P.20 for the way of setting tool conditions.

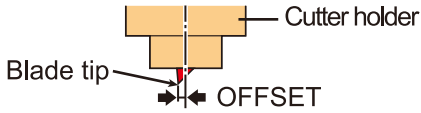
Kinds	Description
<p>Cutting Condition (CUT1 ~ CUT5)</p> <div style="border: 1px solid black; padding: 2px; margin-bottom: 5px;">CUT1 20 050 0.30</div> <div style="border: 1px solid black; padding: 2px; margin-bottom: 5px;">CUT2 20 080 0.30</div> <div style="border: 1px solid black; padding: 2px; margin-bottom: 5px;">CUT3 05 150 0.30</div> <div style="border: 1px solid black; padding: 2px; margin-bottom: 5px;">CUT4 20 060 0.30</div> <div style="border: 1px solid black; padding: 2px;">CUT5 20 070 0.30</div>	<p>This is the tool conditions for using the cutter.</p> <div style="border: 1px solid black; padding: 5px; margin-bottom: 10px;">CUT1 20 050 0.30</div> <p>OFFSET The distance from the center of the cutter holder to the cutter blade</p> <p>PRESSURE The pressure required for cutting</p> <p>SPEED The speed of cutting</p> 
<p>Plotting Condition (PEN)</p> <div style="border: 1px solid black; padding: 2px;">PEN 40 080</div>	<p>This is the tool conditions for using a pen.</p> <div style="border: 1px solid black; padding: 5px; margin-bottom: 10px;">PEN 40 080</div> <p>You need not to set OFFSET.</p>



- Besides the above list, able to set the cutting condition for "POUNCHING" and "HALF CUT". Refer to the operation manual for more detail.

Set the Tool Conditions.

1

Press the **TOOL** key several times to select a tool condition for setting.

TOOL

CUT2 20 080 0.30

- Refer to P.20 for selectable tool conditions
- Select [CUT2] here.

2

Press the jog key  or  to change the SPEED value.





CUT2 50 080 0.30

- The setting values : 1 to 10cm/s (settable by 1cm/s step)
15 to 60cm/s (settable by 5cm/s step)
- Increase the value, and you get the higher speed. Decrease the value, and you get the lower speed. (Set 20 to 30cm/s regularly).

3

Press the **ENTER/HOLD** key or jog key  to move the cursor to PRESSURE.

ENTER/HOLD

 or

CUT2 50 080 0.30

- When you want to return to the previous setting item, press the jog key .

4

Change the value of PRESSURE using the jog key  or .





CUT2 50 100 0.30

- The setting values : 10 to 20g (settable by 2g step)
20 to 100g (settable by 5g step)
100 to 400g (settable by 10g step)

5

Press the **ENTER/HOLD** key or jog key  to move the cursor to OFFSET.

ENTER/HOLD

 or

CUT2 50 100 0.30

- When you want to return to the previous setting item, you must press the jog key .

6

Press the jog key  or  to change the value of OFFSET.





CUT2 50 100 0.35

- The setting values : 0.0 to 2.5mm (settable by 0.05mm step)
- If you have selected the POUNCING condition (PIN) in the Step 1, you must set the pounce interval here. (The setting value: 1 to 100mm (1mm step))

7

Press the **ENTER/HOLD** key or jog key  to secure the setting value.

ENTER/HOLD



or



CUT 2 50 100 0.35

Important!

- When you set PRESSURE to lower than 20g in the Step 4, you must set the setting of SPEED to lower than 10cm/s in the Step 2. Otherwise, the setting may cause the tool to be lifted, and blurred plotting as well as undone cutting.
- Don't perform cutting adjustment only with the protruding amount of the cutter edge while PRESSURE (cutting pressure) remains to be set hard. If cutting is made with the less protruding amount of the cutter edge but with stronger PRESSURE, strange sound may come out during cutting. In addition, the bottom of the cutter and the sheet scrape each other, which may cause the sheet surface to have scratches and which may lower the cutting quality.

Loading a sheet of media

Either a leaf sheet (cut sheet) or a roll sheet can be loaded on the plotter. The pinch rollers and grit rollers hold the sheet in position. Locate the pinch rollers so that they match the sheet to be used.

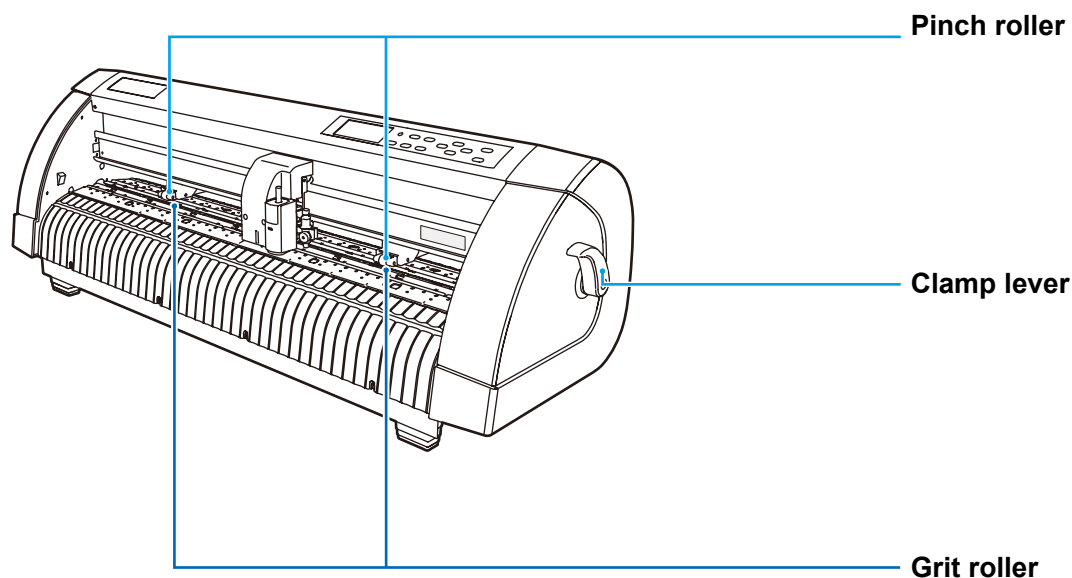

Sheet width available

	mm	inch
Sheet width available	90~740	24

Sheet detection



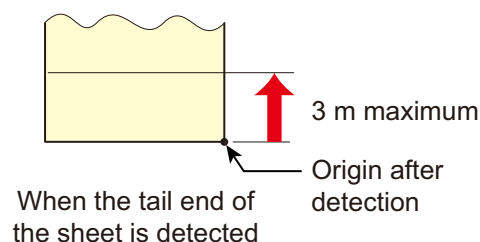

The width and length of the sheet are detected by pressing or key depending on the sheet loaded. (P.24)

Important!

- Once the sheet length has been detected, if the received data is larger than the sheet, the portion of data that exceeds the sheet cannot be used for cutting. If the sheet length is not detected, the plotter will terminate cutting operation when data goes beyond the sheet.
- If the sheet sensor function is set to [OFF], a press of a jog key will make the plotter perform the same sheet detection as the case key is pressed. (Only the sheet width is detected.)
- The maximum length that can be detected at the front and rear ends of the sheet of media is 3 m.





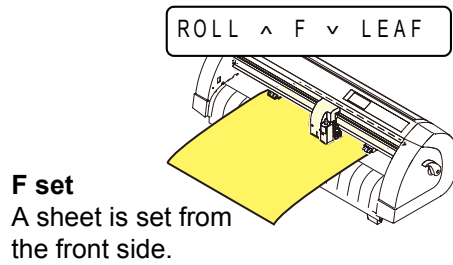
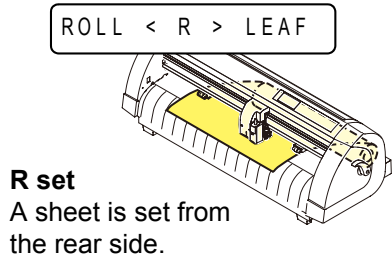

Method of detecting a sheet

When a sheet of media is set, the following two displays will appear alternately on the LCD panel. Align to the direction of the set sheet, and press the jog keys , ,  or  .

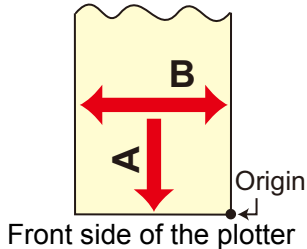
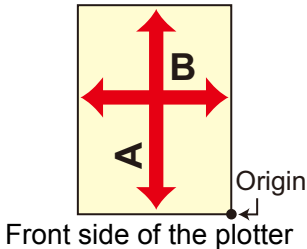
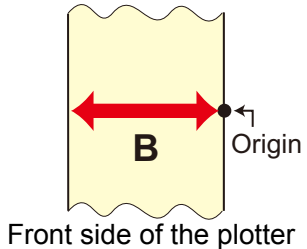

The plotter uses the five different methods to detect a sheet of media as shown below.

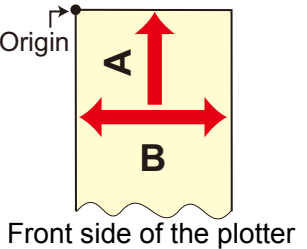
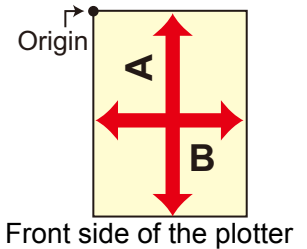
Key	 This key sets the roll sheet in the back side.	 This key sets the discard in the back side.	 This key detects only the sheet width.
Detecting method	After the sheet width is detected, the front end of the sheet is detected. 	After the sheet width is detected, the front and back ends of the sheet are detected. 	The sheet width is detected 
Example of display after the sheet detection	A=**** B=123	A=567 B=123	A=**** B=123
Key	 This key sets the roll sheet in the front side.	 This key sets the discard in the front side.	
Detecting method	After the sheet width is detected, the back end of the sheet is detected. 	After the sheet width is detected, the front and back ends of the sheet are detected. 	
Example of display after the sheet detection	A=**** B=123	A=567 B=123	

Important! • When the detected length is 3 m or more, the display “****” will appear on the LCD.



• When a long sheet of media is used or a sheet which has already been drawn out is used from its middle area, the sheet detection will require an extended period of time. In such a case, the detection time can be reduced by detecting only the sheet width.

Loading a leaf sheet (cut sheet)

1

Press the **SHEET SET** key to switch to **NOT READY** mode.

ROLL < R > LEAF

- You need not to do so if it's already in the NOT READY mode.
Start operation from the Step 2.

2

Load the leaf sheet on the platen.

- (1) Push a clamp lever up to raise a pinch roller.
- (2) Set the right end of the sheet considering the platen vertical rib as the measure.
Or, align the near end of the sheet in parallel with the platen.

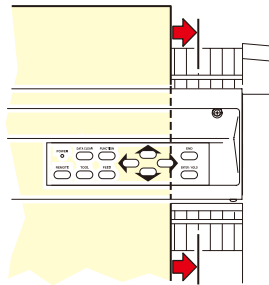
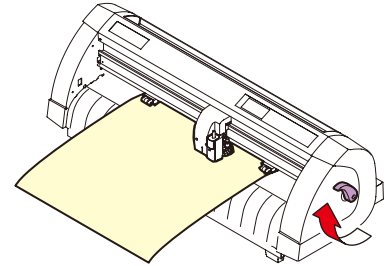

3

Move the pinch rollers so that they suit the sheet width.

- Locate each of the pinch rollers 5 mm or more inside the sheet edge; otherwise, the sheet can slip off the pinch rollers while it is being fed.

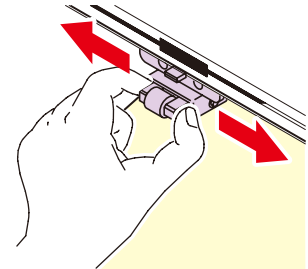

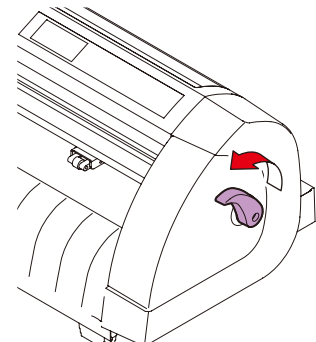

4

Push a clamp lever down to lower the pinch roller.



5

Press the jog key  or  to select "LEAF" .

- "Sheet detection" ( P.23)
- : In the case the sheet is loaded from the rear
- : In the case the sheet is loaded from the front

6

Start detecting the sheet.

- This plotter cannot detect the discard sheet of longer than 3m.

Displays the detected size of the leaf sheet.

A = 6 5 4 B = 4 5 9



Unit : mm

CUT1 20 050 0.30

Displays the current settings of tool conditions.

How to Place the Roll Sheet

If you want to use the roll sheet, you must mount the roll-placing table.

1 Raise the clamp lever.

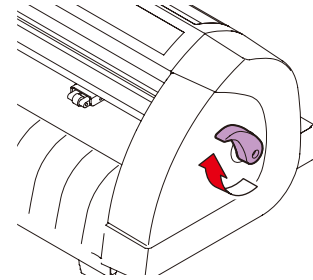

2 Lay down the roll-placing table, fitting to the width of the roll sheet.

- As the roll-placing table has a magnet, just attach it to the device and it is fixed.
- Fix the roll-placing table 2 to 3mm away from the sheet width. Pressing the both ends hard may cause the roll not to be rotated, resulting in no sheet feeding.

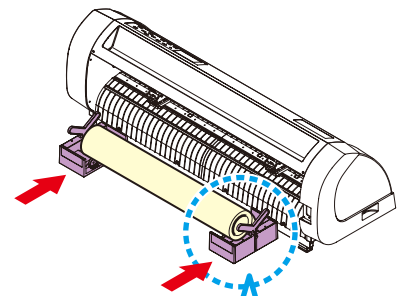

3 Lay up the roll sheet on the roll-placing table.

- Be careful about the sheet direction.

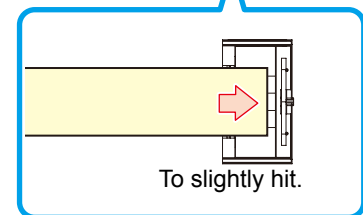
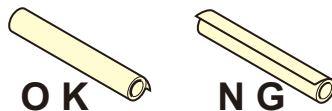

4 Lock the stopper of the roll-placing table.

- The stopper prevents the sheet from rotating when it is pulled out.
- Setting the stopper helps to easily maintain the sheet in the Step 5.

Locked as tilted to the main unit.

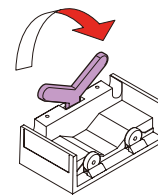



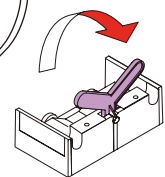

Locked as tilted to the main unit.

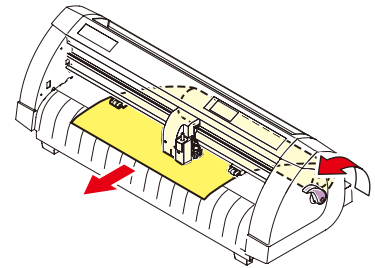
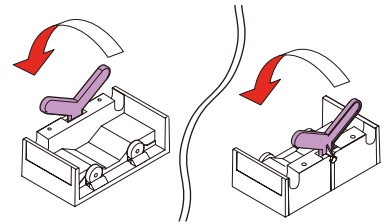
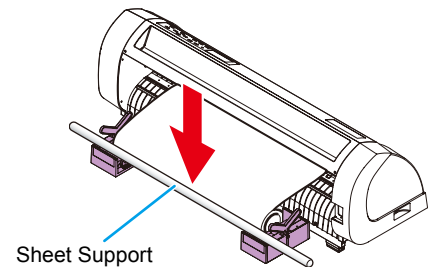

5**Pull out the sheet for maintaining.**

- (1) Pull the sheet tightly and take up the slack.
- (2) Make sure that the sheet is loaded without slack, then raise the clamp lever.
 - When the power is on, the absorbing fan is turned on to absorb the roll sheet.
 - If the power is not on, the absorbing fan is not turned on. Therefore, pressing the sheet with your left hand so as not to be deformed, raise the clamp lever.

**6****Release the stopper for roll-placing table.****7****Install the sheet support to the roll table as shown in illustration.****8****Press the jog key  or  to select [ROLL].**

- "Sheet detection" ( P.23)
-  : In the case the sheet is loaded from the rear
-  : In the case the sheet is loaded from the front

9**Start detecting the sheet.**

Displays the detected size of the leaf sheet.

A = 6 5 4 B = 4 5 9



Unit : mm

CUT 1 2 0 0 5 0 0 . 3 0

Displays the current settings of tool conditions.

10**Press the  key to pull out the sheet of the length you want to use.****Important!**

- Before you use the roll sheet, previously pull out the sheet of the length you use to make enough room. By feeding out the sheet, you can verify if there is any sheet misalignment or not.

Test cutting (plotting)

Execute test cutting (plotting) to confirm the tool conditions.
In the test cutting, the plotter cuts two squares.

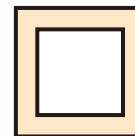

Important!

- When the cutter blade is worn and dull, you can use it temporarily by enhancing the value of PRESSURE. However, you are recommended to replace the worn cutter blade with a new one to ensure a satisfactory cutting quality.



- When the tool conditions are proper, the results of test cutting (plotting) are as follows:
The two squares are cut perfectly.
The base sheet remains uncut.
No corner of the squares is round.
No corner of the squares is curled-up.

1

Confirm that the plotter is in the local mode.

CUT1 20 050 0.30

2

Press the **FUNCTION key a few times to select [SQUARE CUT].**



SQUARE CUT <ENT>

3

Press the **ENTER/HOLD key .**

- The plotter will execute test cutting (plotting) and then return to the local mode display.

Change the settings of the cut conditions according to the test cutting (plotting) results.

Cut Condition	Cause	Remedy
Some parts uncut.	The blade floats above the sheet because of a too high cutting speed.	Lower the speed.
		Tighten up the thumbscrew for the tool holder.
The base sheet has been cut.	Too high pressure.	Lower the pressure.
	Too large protrusion of the cutter blade.	Adjust the protrusion of the cutter blade.
Any of the square corners rounded.	Improper OFFSET value.	Adjust the OFFSET value so that it suits the cutter blade in use.
Any of the square corners curled-up.	The protruding amount of the cutter edge is too much. The cutting pressure is higher. The [COMPENSATION PRESSURE OFFSET value] is greater. More than two out of the above fall under this category.	Adjust the protrusion of the cutter blade.
		Adjust the cut pressure
		Adjust the ADJ-PRS OFS value

Cutting (plotting)

You can start cutting (plotting) after completion of setting up a tool, loading a sheet and setting the tool conditions.

Setting the origin

The origin is a reference point for the cutting (plotting) data.





When the origin is to be changed, set the new origin before starting cutting (plotting).

Important!

- Change the origin before you make the plotter start cutting for the next data; otherwise, cutting will be performed over the previous data.

1

Move the head to a point at which the new origin is to be set.

- : Moves the head to the right.
- : Moves the head to the left.
- : Feeds the sheet toward the rear of the plotter.
- : Feeds the sheet toward the front of the plotter.
- Every time you press the  key, the tool will move up and down alternately. This helps you to set the origin at a correct position.

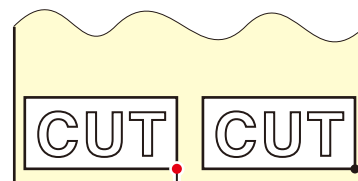

New origin

2

Press the  key to register the origin.

- The display panel will show the effective cutting area first and then the tool conditions.

ENTER/HOLD



** ORIGIN **



A = * * * * B = * * * *



CUT 1 20 050 0.30

Start cutting (plotting)

1

After completion of setting the origin, press the **REMOTE** key.



CUT 1 * REMOTE *

- The display changes to REMOTE.

2

Send the data to the plotter.

- On receiving the data, the plotter performs cutting (plotting) while displaying the remaining amount of the data.
- Upon completion of cutting (plotting), the display changes as shown at right.

CUT 1 * 1356KB *



When the cutter is selected

CUT 1 * REMOTE *

When the pen is selected

PEN * REMOTE *

Bringing the cutting (plotting) to a halt

To temporarily stop the plotter during cutting (plotting), press the **REMOTE** key once. Another press of the key will make the plotter resume cutting (plotting).

Important!

- In case the sheet has slipped off the plotter during cutting operation, turn off the power immediately; otherwise, the main unit may be damaged.



- The LCD will show the following error message if you try to execute any function that can initiate some action during temporary suspension or any operation that can affect the command coordinate system.

ERR34 DAT REMAIN

- If the error message appears, let the plotter complete the cutting for the remaining portion of the data or discontinue the cutting by executing data clearing ( OPERATION MANUAL).

Cut off the Sheet (Manual Cutting)

1

Confirm that the plotter is in the local mode.

CUT1 20 050 0.30

2

Enter the sheet feed length by pressing the jog key .



50.0 0.0

- Setting value: 0.1m to 51.0m (0.1m step)

3

Press the  key or  key.

ENTER/HOLD



OR

END

4

Press the  key.

ENTER/HOLD



ROLL < R > LEAF

5

Hold the sheet by hand.

- Make sure to hold firmly to avoid the sheet raise up.

6

Cut the sheet

- (1) Push the (A) part of manual cutter down.
 - (2) Move the carriage and cut.
- When cutting a sheet, be careful for the cutter blade direction. Carriage must be moved to the direction of able to cut.

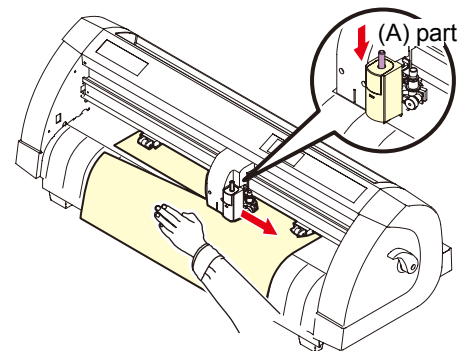

Turning the power off

When plotting is completed, press the “ O ” side of the power switch to turn the power off.

Important!

- Once the power is turned off, wait at least five seconds before turning the power on again.

1

Confirm that the plotter is not receiving any data.

- Make sure that the display is indicating REMOTE or LOCAL.

CUT1 * REMOTE *

CUT1 20 050 0.30

2

Press the “ O ” side of the power switch.

- The POWER lamp on the operation panel turns off.

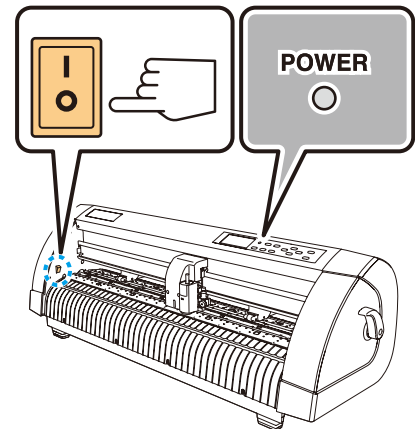

Cut Out Data with Registration Mark

Making sticker with a register mark (When using FineCut)

Create registration marks on an output image that you want to make a seal, and then the plotter detects them to cut it out.

1

Make frame around the image.

- Make frame with an attached plug-in soft “FineCut”

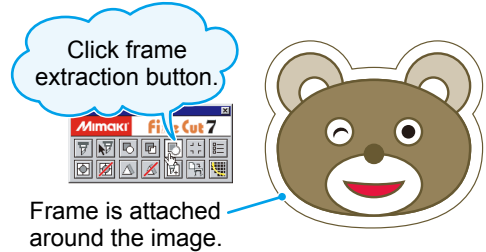

2

Make register mark.

- Make register mark at corners of image.
- Cutting start position is settled according to the register mark.
- Use “FineCut” to make a register mark.
- Refer to P.36 to P.39 for the limitation of making a register mark.

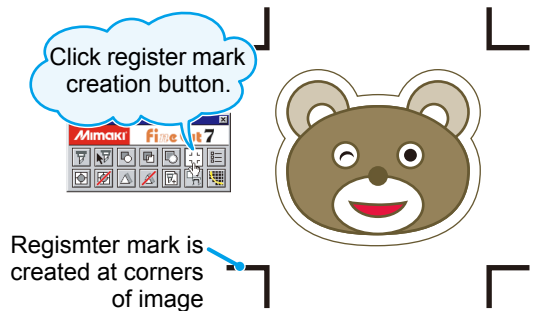

3

Print the image with register mark.



4

Load the sheet to CG-60SR.

- Refer to P.18 for loading the sheet.

5

Send the data with “FineCut” from computer, and cut.



- For the operation of plug-in software FineCut, refer to the operation manual provided with a FineCut CD-ROM.

Register mark type

There are following two types of registration marks.

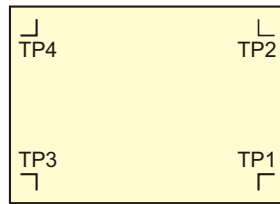

Registration mark: Type 1

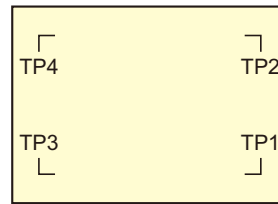

Registration mark: Type 2



- Use the TP4 when performing trapezium compensation to correct the uneven sheet feeding rate caused by the difference in the diameter between the right and left grit rollers. If the trapezium compensation is to be omitted, there is no need to set the TP4. In that case, however, cutting distortion will increase.

Enter the registration mark detection mode

1

Press the **END** key in the local mode.

- It turns out to be a registration mark detection mode.



- When the registration detection is set to OFF, it doesn't enter into the registration mode. (☞ P.40)
- While various functions are under setting, data entry may be cancelled and the plotter may go back to the previous setting item.

Precautions in inputting data with registration marks

There are some limitations on preparing data with registration marks. In order to make full use of this function, read the following instructions carefully and prepare data with registration marks properly.

- Important!** • The registration mark described here is intended to detect the sheet inclination and the lengths along the A and B axes. It is not a mark for trimming.

Size of the registration marks

Refer to "The size of, and the distance between, registration marks" (P.38) for the relationship between the data and the length of one side of a registration mark.

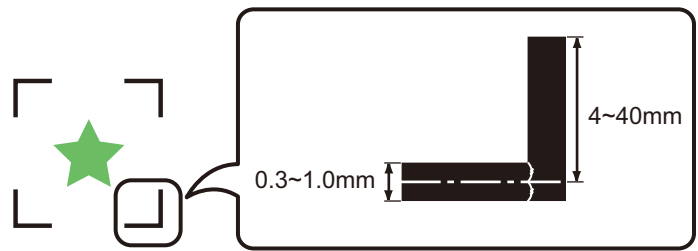

The area where registration marks and designs can be arranged

- The TP1 starting position must be 20 mm or more away from the leading edge of the sheet.
- The TP2 end position must be 30 mm or more away from the tail end of the sheet.

Mark Form : Type 1

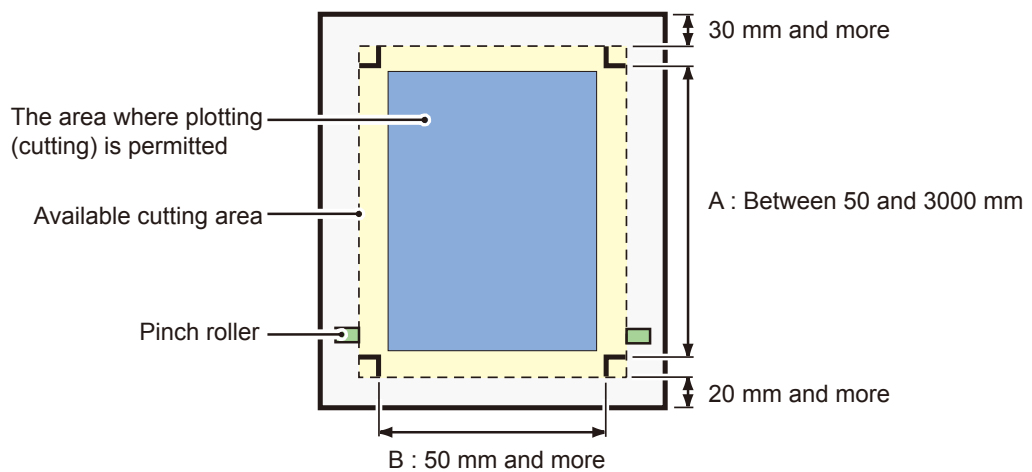

Mark Form : Type 2

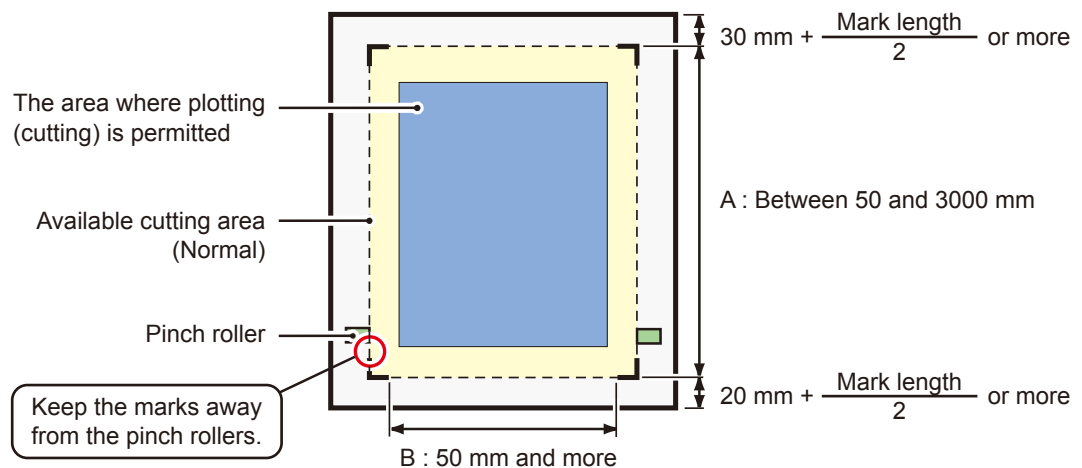

No-plotting area around the registration marks

An area around a registration mark (from the mark origin to the mark size area) is a non-plotting area. There must be no data plotted or stain in this area; otherwise, a wrong origin may be detected or a mark read error can occur.

- Important!** • If a wrong mark origin is detected, the cutting will be performed in a wrong area.

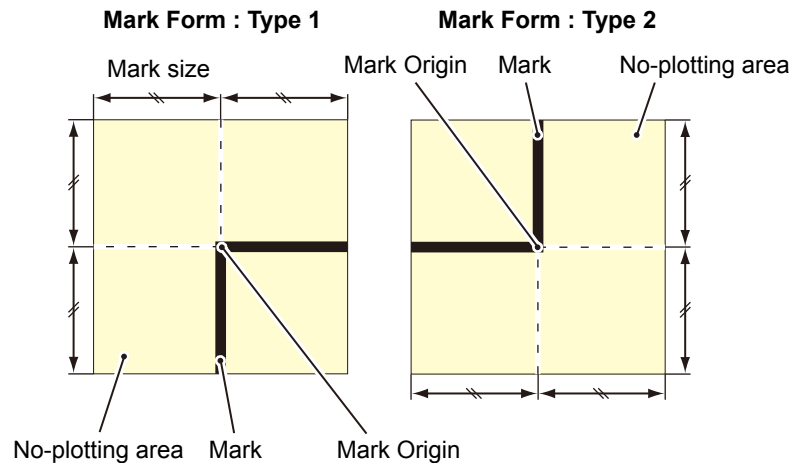

Example of cause of wrong detection 1

There is a line outside the registration marks

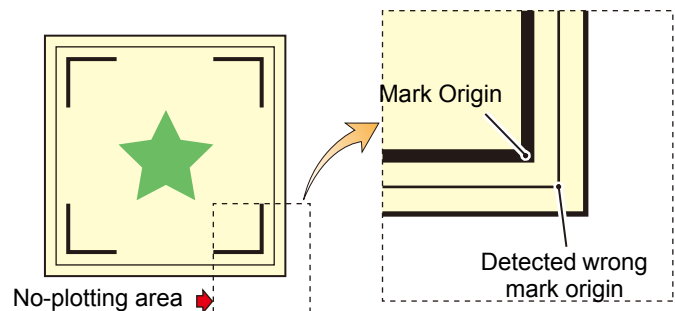

Example of cause of wrong detection 2

The distance between registration marks (TP2 and TP1 or TP4 and TP2) is smaller than the mark length (for Type 2)

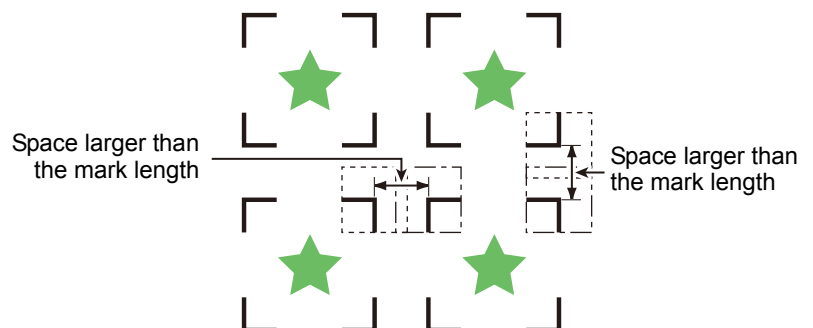

The size of, and the distance between, registration marks

The size (B) of a registration mark suited for the distance (A) between the marks is as shown below. If the mark size (B) is too small relative to the distance (A), the marks may not be detected correctly. Be sure to prepare the registration marks with an appropriate size.

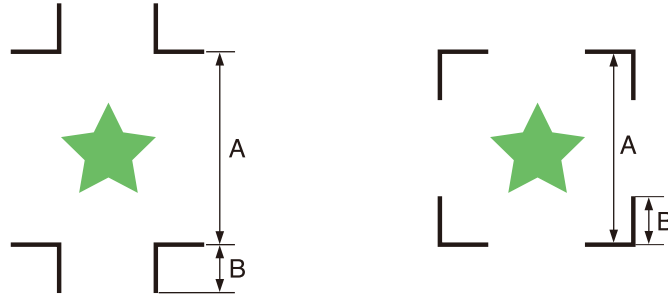

A	200 and less	500	1000	2000	3000 and more
B	4~	8~	15~	25~	35~

(mm)

Distance between registration marks for copied designs

For Type 1 registration marks, the distance between the marks must be not shorter than two times the mark length and not longer than 1000 mm. For Type 2 registration marks, the distance between the marks must be not shorter than the mark length and not longer than 1000 mm.

Mark Form : Type 1

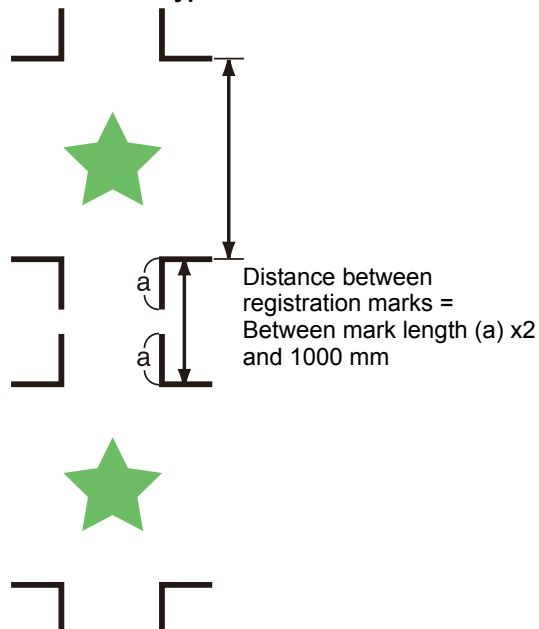

Mark Form : Type 2

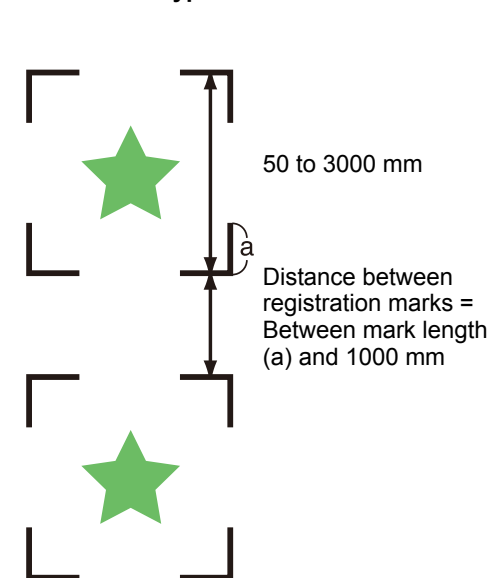

Recommended size of the area defined with a set of four registration marks

It is recommended that the size of the area defined with a set of four registration marks is in the range of A4 size (210 mm x 297 mm) to A3 size (297 mm x 420 mm). If you follow this recommendation, you can minimize wasteful spaces and arrange the designs efficiently.

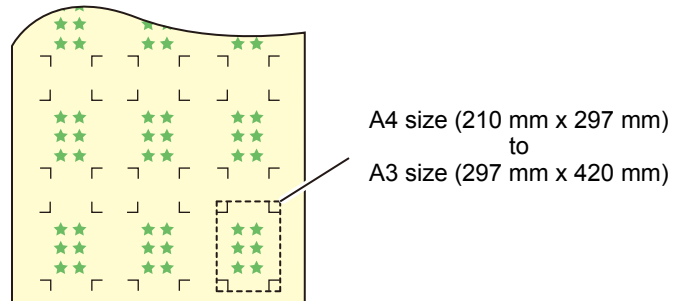

Color of mark

The mark must be printed in black against the white background.

The registration mark will not be detected correctly if the background is not white or the mark is not black.

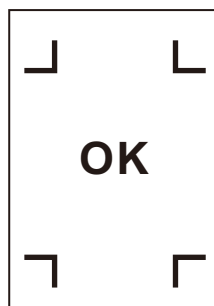

Mark blurred

If the mark is blurred, a wrong mark origin can be detected, thus resulting in deviated cutting.



Set for Detecting the Registration Marks

When you want to cut the data with registration marks, you must set the following without fail.

1

Press the **FUNCTION** key in the local mode.



DATA CLEAR <ENT>

2

Press the jog key or to select [SET UP].



SET UP <ENT>

3

Press the **ENTER/HOLD** key.



4

Press the jog key or to select [MARK DETECT].



MARK DETECT <ent>

5

Press the **ENTER/HOLD** key.



MARK DETECT : OFF

6

Press the jog key or to select [Number of detected registration marks].



MARK DETECT : 2 p t A

- Set values: OFF, 1pt, 2ptA, 2pt B, 3pt, and 4pt

7

Press the **ENTER/HOLD** key.

- In case you selected “OFF” in Step 6, proceed to Step 12.

8

Press the jog key or to select the following items.

- The following items are provided for the setting of registration mark detection: Scale compensation, registration mark size, offset A, offset B, form of registration mark, number of continuous cutting in direction A, number of continuous cutting in direction B, high speed limit, skew check, and detect mode
- See pages P.41 through P.44 for the contents of each setting item.

9

Press the **ENTER/HOLD** key..

10

Press the jog key **▲** or **▼** to select the set values.

- See pages P.41 through P.44 for the contents of each setting item.

11

Press the **ENTER/HOLD** key to confirm the value.

12

When you want to terminate this procedure, press the **END** key twice.

Setting Items

Setting the Number of Registration Mark Detection

The higher the number of detected points, the higher the cutting accuracy.

- Important!** • Select “1pt” when using FineCut.

Setting	Description
OFF	Select this setting for cutting a normal sheet, not for cutting the outline.
1pt	Detects the TP1. Sets only the origin.
2pt A	Detects the two registration marks TP1 and TP2. Performs the skew compensation and the scale compensation in the sheet feeding direction.
2pt B	Detects the two registration marks TP1 and TP3. Performs the skew correction and the scale compensation in the width direction.
3pt	Detects the three registration marks TP1, TP2 and TP3. Performs the skew compensation and the scale compensation in the sheet feeding and the width direction.
4pt	Detects the four registration marks TP1, TP2, TP3 and TP4. Performs the skew compensation, the scale compensation in both directions, and the trapezium compensation.

DIST.REVI

Select "OFF" when using FineCut.

Setting	Description
OFF	The plotter will not perform any scale compensation.
BEFOR	With this setting, enter the scale compensation values and the trapezium compensation*1 value before executing the registration mark detection. (☞ P.46 , ☞ P.49) Since the distance between registration marks is entered beforehand, rapid movement is expected when detecting.
AFTER	With this setting, enter the scale compensation values and the trapezium compensation value*1 after executing the registration mark detection. (☞ P.46 , ☞ P.49) Since there is an understanding of the distance between marks, setting values can be input rapidly. The AFTER setting will take less time than the BEFORE setting.

*1: The diameter difference between the grit rollers may cause a significant difference in the sheet feeding distance between the right side and the left side. The trapezium compensation function correct this difference in sheet feeding between the right side and the left side.

Size

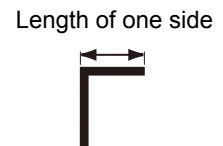

Setting	Description
4 ~ 40mm	Set the length of one side of the registration mark. When the printed mark's horizontal and vertical lengths differ from each other, set the same value as the shorter length.



Offset A, Offset B

Setting	Description
± 40.00mm	Generally the origin will be set at the position shown below. However, the position information of the origin may differ depending on the application software. In this case, the location of the origin can be corrected. <div style="display: flex; justify-content: space-around; align-items: center;"> <div style="text-align: center;"> <p>Mark: Type 1</p> <p>Plus A direction (up), Plus B direction (left)</p> </div> <div style="text-align: center;"> <p>Mark: Type 2</p> <p>Plus A direction (up), Plus B direction (left)</p> </div> </div> <p>If the origin is located out of the available cutting area, "ERR37 MARK ORG" will be displayed. In this case, write the registration marks in the area closer to the center of the sheet.</p>

MARK FORM

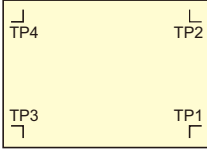
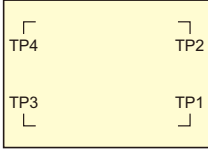
Setting	Description
TYPE1  TYPE2 	<p>Select either one of the following types of registration marks.</p> <div style="display: flex; justify-content: space-around; align-items: center;"> <div style="text-align: center;"> <p>Mark: TYPE1</p>  </div> <div style="text-align: center;"> <p>Mark: TYPE2</p>  </div> </div>

COPIES A (UP), COPIES B (LEFT)

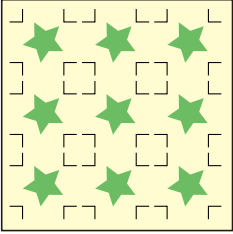
Setting	Description
1 ~ 9999 (COPIES A) 1 ~ 99 (COPIES B)	<p>Effective when the same pattern is multi-printed at regular intervals. Cuts automatically the preset number of sheets while detecting registration marks consecutively based on the first data.</p> <div style="display: flex; align-items: center;"> <div style="text-align: center; margin-right: 20px;">  <p>3x3 copies</p> </div> <div> <p>For leaf sheets (cut sheets), the value of [COPIES A] is used as the number of copies. When the number of copies can be set on the application software, like on the supplied FineCut, set the value to [1].</p> </div> </div>

SPD LIMIT

Setting	Description
0 ~ 50cm/s	<p>Set a speed limit for rapid moving in continuous copying. During rapid moving, mark detection may not be performed correctly if a slippery sheet is used. In such a case, set a speed limit. If no speed limit is required, set the value to “0” .</p>

SKEW CHECK

Setting	Description
0 ~ 99mm	<p>Set the allowable range of the sheet feeding error when performing continuous copy.</p> <p>During continuous copying on a roll sheet, copies may be misaligned little by little because of sheet skewing. If the error in the B-axis coordinate of the TP1 mark has exceeded the allowable range, cutting operation is temporarily stopped.</p> <p>Press the ENTER/HOLD key after correcting the sheet feeding error. Then the plotter waits for mark detection.</p> <p>Move the light pointer to the position shown below with jog keys and press the ENTER/HOLD key. Then the light pointer starts mark detection. If skew check is to be omitted, set the value to "0".</p> <div style="text-align: center;"> <p>Mark: TYPE1 Mark: TYPE2</p> <p>Reference mark 1 Reference mark 2 (TP1)</p> <p>(TP1) (TP1)</p> <p>Starting point for mark detection</p> </div>

DETECT MODE

Setting	Description
FAST	<p>The position is determined by scanning the registration mark segment back and forth once.</p> <p>Time required for detection is short, however, the accuracy becomes lower a little.</p>
PREC	<p>After scanning the registration mark segment back and forth once, measures the position without fail by scanning the segment included its outside again.</p> <p>Time required for detection becomes slightly longer.</p>

Reset the Setting of Registration Mark Detection

In case the plotter detects the sheet that has no printing of registration marks and displays [SEARCH START POS] you must set the registration mark detection to "OFF." Then, the registration mark detection becomes rendered ineffective.

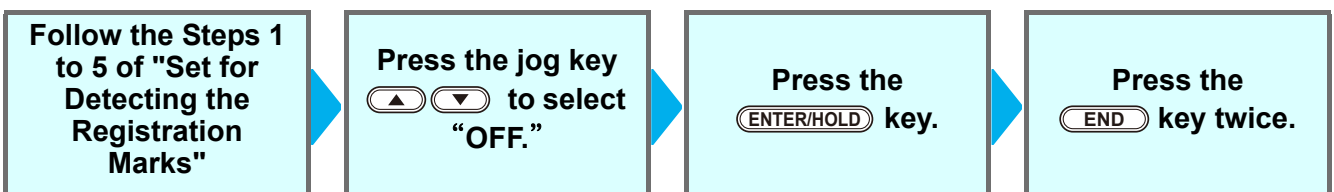

Method of detecting registration marks

Registration marks are detected in two different ways; full-automatic detection and semi-automatic detection. Use the semi-automatic function when the TP1 is not located at the bottom right of the sheet, or when the supplied FineCut is to be used as the cutting software.

Important!

- If the sheet is curled, straighten it.
- When using a cutting software having no mark function, use a sheet which has neither stains nor images in the area (A) located between TP1 and TP2 and in the area (B) located between TP1 and TP3.

Check sheet skew with a light pointer

Depress the clamp lever, raise the pinch roller and reset the sheet with the **SHEET SET**. And then the Light Pointer is turned lit.

You can manually move the carriage to the left and right. Depress the clamp lever, and manually move the carriage between the registrations TP1 and TP3. Then you can confirm the sheet inclination by the move line of Light Pointer. Align to the move line and adjust the sheet inclination.

Important!

- If no operation is performed for five minutes, the light pointer will automatically go out.

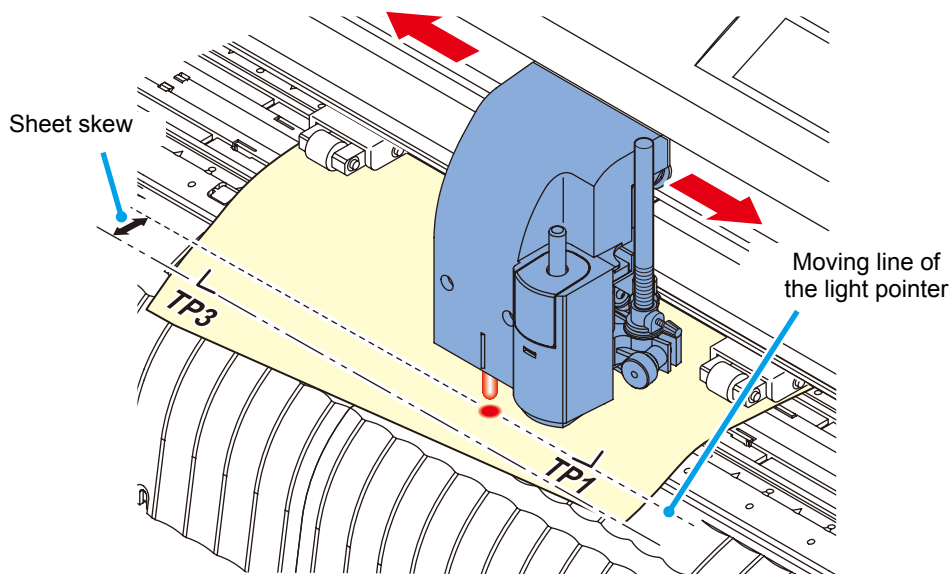

Full-automatic detection of marks

Use this function to correct the error in the detected length between registration marks as compared with the printed length between registration marks. For this purpose, measure the length A and B on the data beforehand.

Measure the length between the registration marks.

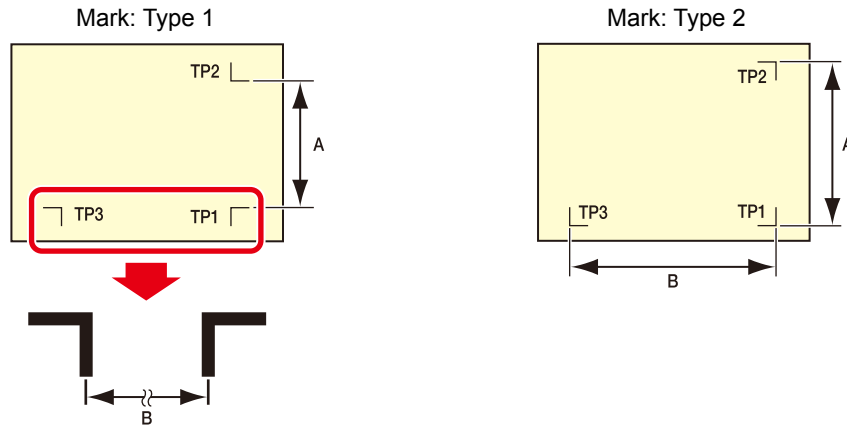

Detecting procedure ([DIST.REVI.] Setting value is “BEFOR”)

Important!

- Be sure to set the sheet in the rear.

1

Measure the lengths A and B on the data to be output.

2

Place TP1 at a location shown at right.

- If it is impossible to place the registration mark TP1 at the location shown in the sketch, follow the procedure for “Semi-automatic registration mark detection” .

3

You must take care to tighten the sheet, and raise the clamp lever.

- Then the pinch rollers will retain the sheet.

4

Press the **ENTER/HOLD key.**

- The scale compensation display appears after detecting only the sheet width. (The right figure shows the 4-point detection display as an example.)

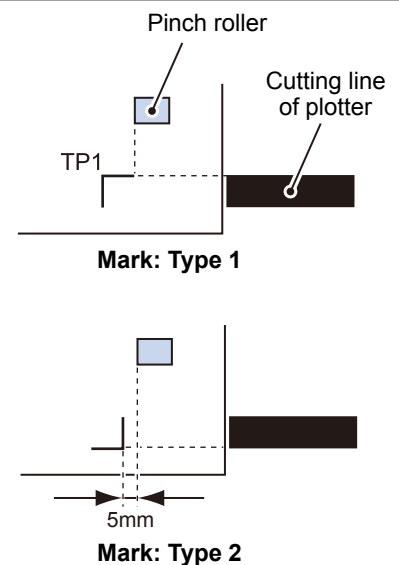

ENTER/HOLD



ROLL < R > LEAF



A (1 - 2) = * * * . *

5

Set with the jog key or .

- Press the  key. And the plotter moves to the next scale compensation setting.
- If [MARK DETECT] is set to [2ptA], the display for inputting the B length will not appear.
- If [MARK DETECT] is set to [1pt], the scale compensation setting display will not appear but the origin point will be displayed. (Step 7)

A (1 - 2) = * * * . *



B (1 - 3) = * * * . *

6

Press the key after completing the settings.

- The registration mark detection will be started.
- See "Setting the Number of Registration Mark Detection" ( P.41) for the number of registration marks.
- In case the plotter cannot detect any registration marks, it displays "Error 36 in the registration mark detection" on the display. Set the sheet again.

ENTER/HOLD



B (1 - 3) = * * * . *



* * MARK DETECT * *

7

Set the origin.

- After the detection of the registration marks, the display will show the available cutting area and then return to local mode.

* * ORIGIN * *



A = * * * * B = * * * *



CUT 1 20 050 0.30

Detecting procedure ([DIST.REVI.] Setting value is "AFTER")

Important!

- Be sure to set the sheet in the rear.

1

Follow steps 1 to 3 of "Detecting procedure ([DIST.REVI.] Setting value is "BEFOR")" (☞ P.46)

2

Press the **ENTER/HOLD** key.

- The registration mark detection will be started after detecting only the sheet width.
- See "Setting the Number of Registration Mark Detection" (☞ P.41) for the number of registration marks.
- In case the plotter cannot detect any registration marks, it displays "Error 36 in the registration mark detection" on the display. Set the sheet again.

ENTER/HOLD



ROLL < R > LEAF



** MARK DETECT **

3

After the detection of the registration marks, the scale compensation display appears.

- The right figure shows the 4-point detection display as an example.
- If there is a difference between the actually measured value and the detected length, make setting with the jog key (▲) or (▼).
- Press the **ENTER/HOLD** key to change the display to the next scale compensation setting.
- If [DIST. REVI.] is set to [OFF], the display for scale compensation setting will not appear.
- If [MARK DETECT] its set to [2ptA], the display for inputting the B length will not appear.
- If [MARK DETECT] is set to [1pt], the display for scale compensation will not appear. Proceed to Step 4 and set the origin.

A (1 - 2) = * * * . *



B (1 - 3) = * * * . *

4

Press the **ENTER/HOLD** key after completing the settings.

- Set the origin.
- The display will show the available cutting area and then return to local mode.

ENTER/HOLD



** ORIGIN **



A = * * * * B = * * * *



CUT 1 20 050 0.30

Semi-automatic detection of registration marks

When TP1 cannot be located at the position where it can be detected full-automatically or when no registration mark can be detected full-automatically, perform registration mark detection semiautomatically.

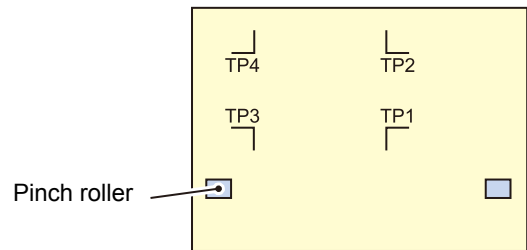

Detecting procedure ([DIST.REVI.] Setting value is "BEFOR")

1

Load the sheet and lower the clamp lever.

- Then the pinch rollers will retain the sheet.

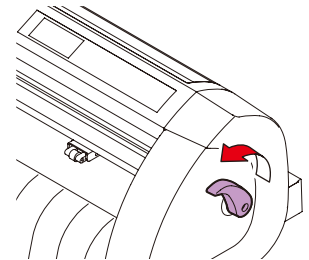

2

Perform the sheet detection by pressing the jog key ◀ or ▶ . (Set the sheet in the rear.)

- Once the sheet is detected, the display indicates that the plotter is waiting for registration mark detection operation.
- When the sheet is set in the front, the positions of the TP1 to TP4 are viewed inverted as shown at right.

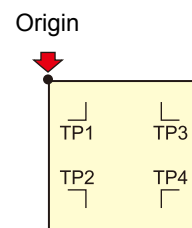
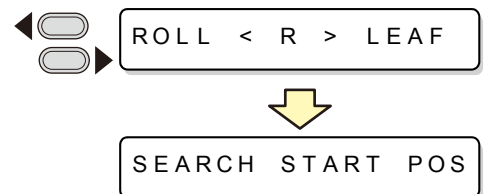

3

Move the Light Pointer into the area shown below by pressing the appropriate ones of the jog keys ▲ ▼ ◀ ▶ .

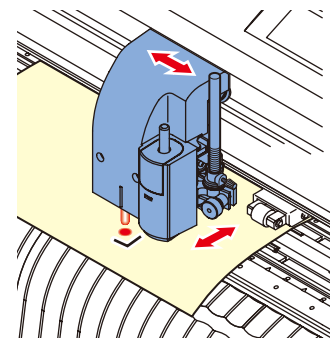
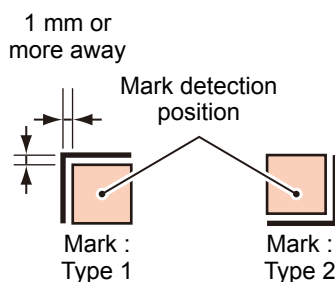

4

Press the **ENTER/HOLD** key.

- The scale compensation display appears. (The right figure shows the 4-point detection display as an example.)



SEARCH START POS



A (1 - 2) = * * * * . *

5

Make setting with the jog key  or .

- Press the **ENTER/HOLD** key to change the display to the next scale compensation setting.
- If [DIST.REVI.] is set to [OFF], the display for scale compensation setting will not appear.
- If [MARK DETECT] its set to [2ptA], the display for inputting the B length will not appear.
- If [MARK DETECT] is set to [1pt], the scale compensation setting display will not appear but the origin point will be displayed.

A (1 - 2) = * * * * . *



B (1 - 3) = * * * * . *

6

Press the **ENTER/HOLD** key after completing the settings.

- The plotter will start detecting the registration marks according to the settings of [MARK DETECT].
- See "Setting the Number of Registration Mark Detection" (P.41) for the number of registration marks.
- In case the plotter cannot detect any registration marks, it displays "Error 36 in the registration mark detection" on the display. Set the sheet again.



B (1 - 3) = * * * * . *



* * MARK DETECT * *

7

Set the origin.

- The display will show the available cutting area and then return to local mode.

* * ORIGIN * *



A = * * * * B = * * * *



CUT1 20 050 0.30

Detecting procedure ([DIST.REVI.] Setting value is “BEFOR”)

1

Follow steps 1 to 3 of "Detecting procedure ([DIST.REVI.] Setting value is “BEFOR”)" (☞ P.49)

2

Press the **ENTER/HOLD** key.

ENTER/HOLD





** MARK DETECT **

- The plotter will start detecting the registration marks according to the settings of [MARK DETECT].
- See "Setting the Number of Registration Mark Detection" (☞ P.41) for the number of registration marks.
- In case the plotter cannot detect any registration marks, it displays “Error 36 in the registration mark detection” on the display. Set the sheet again.

3

After the detection of the registration marks, the scale compensation display appears.

A (1 - 2) = * * * . *

- The right figure shows the 4-point detection display as an example.
- If there is a difference between the actually measured value and the detected length, make setting with the jog key  or .
- Press the **ENTER/HOLD** key to change the display to the next scale compensation setting.
- If [DIST.REVI.] is set to [OFF], the display for scale compensation setting will not appear.
- If [MARK DETECT] is set to [2ptA], the display for inputting the B length will not appear.
- If [MARK DETECT] is set to [1pt], the scale compensation setting display will not appear but the origin point will be displayed.

4

Press the **ENTER/HOLD** key after completing the settings.

- Set the origin.
- The display will show the available cutting area and then return to local mode.

** ORIGIN **



A = * * * * B = * * * *



CUT 1 20 050 0.30

Confirm the following when failed in cutting correctly.

Check the sensor for the registration mark detection

Important!

- If you move the head and sheet manually, you cannot perform the right response check. Be sure to perform it via the following operations.

1

Make sure that the plotter is in local mode.

CUT1 20 050 0.30

2

Enter the jog mode by pressing the jog key  or .

3

Turn on the Light Pointer by pressing the **REMOTE** key.

4

Move the Light Pointer to the registration mark detection position by pressing the appropriate ones of the jog keys  and .

- Perform registration mark detection at a position 1mm or more away from the registration mark.

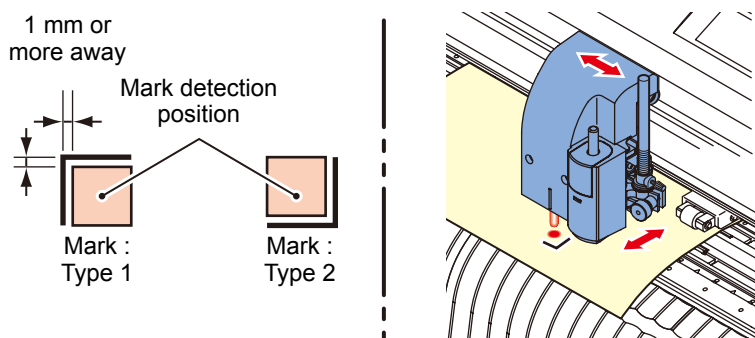

5

Press the **END** key to terminate the jog mode.

- The plotter returns to the local mode.

6

Press the **FUNCTION** key.

FUNCTION



DATA CLEAR <ENT>

7

Select [MARK sensor] by pressing the jog key  or  .



MARK sensor <ENT>

8

Press the  key.

ENTER/HOLD



SENSOR CHK <ent>

9

Press the  key after confirming [SENSOR CHK] is displayed.

10

Select the length of the registration mark, shape of the registration mark, and speed of the registration mark detection.

SIZE : 10mm

FORM : TYPE 1 

- For details on setting the [SIZE] and [FORM], refer to the [MARK DETECT] setting procedure. ( P.36)

11

Perform registration mark detection with the jog key  . (Next page)

Detect operation

1**Scan in the B direction (plus direction) to detect the line.**

- The buzzer sounds when the line is detected. If the line is not detected, the buzzer does not sound.

2**Scan in the B direction (minus direction) to detect the line.****3****Scan in the A direction (plus direction) to detect the line.****4****Scan in the A direction (minus direction) to detect the line.****5****Follow the Steps 1 to 4, and confirm if the buzzer sounds 4 times.**

- When the detection behavior completes successfully, the buzzer sounds 4 times.
- If the plotter failed to detect the line, perform "Adjust the sensitivity (light intensity) of the mark sensor LED (automatically)" (P.56)
- If the plotter cannot detect the line successfully even after you adjusted the sensitivity, you must verify the registration conditions and contact our sales branches (for service call).

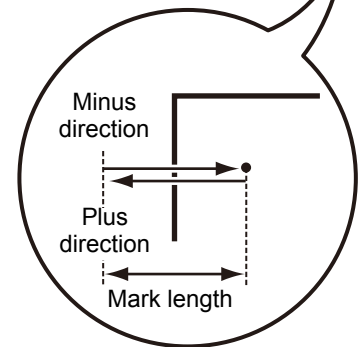
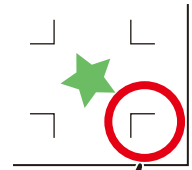

Scan in the A direction

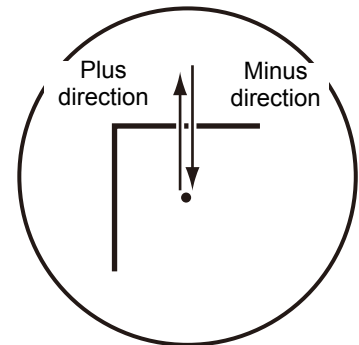

Scan in the B direction

Correct the light pointer position

If the plotter fails to recognize any registration mark properly, the possible cause is an error in the positional relationship between the MARK sensor and the light pointer. In this case, adjust the position of the light pointer.

1 Install a water-based ball-point pen in the tool holder.

- When making an adjustment, use the pen dedicated for the plotter to reduce the fudge factor. Any pen color works for the adjustment. You can order the dedicated pen from a sales office of MIMAKI.

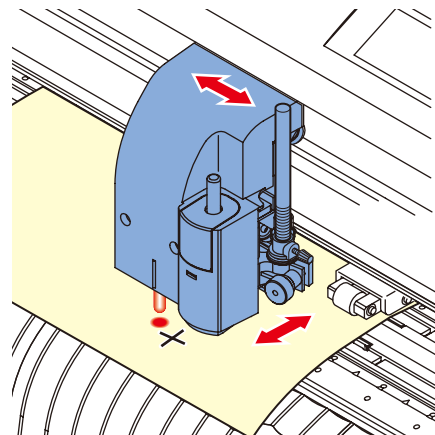

2 Confirm that the plotter is in the local mode.

CUT1 20 050 0.30

3 Press the **FUNCTION** key.

FUNCTION



DATA CLEAR <ENT>

4 Select [MARK SENSOR] by pressing the jog key **▲** or **▼**.



MARK sensor <ENT>

5 Press the **ENTER/HOLD** key.

ENTER/HOLD



SENSOR CHK <ent>

6 Select [SENSOR OFS] by pressing the jog key **▲** or **▼**.



SENSOR OFS <ent>

7 Press the **ENTER/HOLD** key.

ENTER/HOLD



A = - 3 . 9 B = - 6 . 0

- A 10 mm by 10 mm cross pattern will be plotted.
- The light pointer turns on and moves to the center of the cross pattern.

8

By pressing the jog keys    and , adjust the light pointer position so that the center of the light pointer is in alignment with the center of the cross pattern.

9

Press the  key.



CUT1 20 050 0.30

- The plotter will return to the local mode after registering the compensation value.

Important!

- The value registered in the [POINTER OFS] is not initialized even by executing the [SETUP RESET].

Adjust the sensitivity (light intensity) of the mark sensor LED (automatically)

If an error occurs frequently in registration mark detection, a possible cause is an improper sensitivity of the mark sensor LED.

In this case, adjust the sensitivity (light intensity) of the mark sensor LED.

Important!

- Make sure that the sheet is clean and white, and locate the sheet directly under the sensor.





1

Make sure that the plotter is in local mode.

CUT1 20 050 0.30

2

Confirm that the mark sensor is located just above a plain area (non-printed area) of the sheet.

- If the mark sensor is not located just above a plain area, correct the location with jog keys    and .

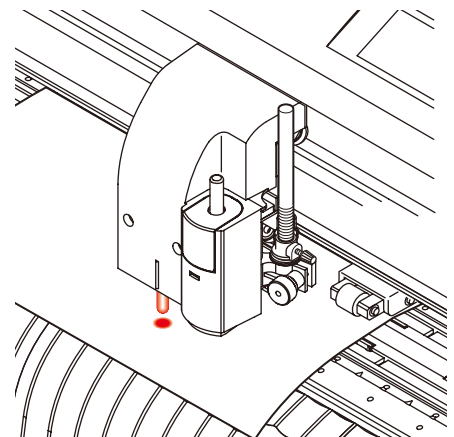

3

Press the  key.



DATA CLEAR <ENT>

4

Select [MARK sensor] by pressing the jog key  or  .



MARK sensor <ENT>

5

Press the  key.

ENTER/HOLD



SENSOR CHK <ent>

6

Select [LEVEL ADJ] by pressing the jog key  or  .

ENTER/HOLD



LEVEL ADJ <ent>

7

Press the  key.

8

This plotter automatically performs the sensitivity adjustment.

OUT: * * * * IN: * * * *

9

Press the  key after making certain that the display is showing a number steadily.

- The display may not become so steady that it keeps showing only one fixed number. In that case, press the  key when the value of the high-order digit on the display is fixed.
- The plotter will return to the local mode after registering the adjusted value.

